

# Functional contribution of Pds5 to cohesin-mediated cohesion in human cells and *Xenopus* egg extracts

Ana Losada\*, Tomoki Yokochi<sup>‡</sup> and Tatsuya Hirano<sup>§</sup>

Cold Spring Harbor Laboratory, 1 Bungtown Road, Cold Spring Harbor, NY 11724, USA

\*Present address: Spanish National Cancer Centre (CNIO), Melchor Fernández Almagro 3, Madrid 28029, Spain

<sup>‡</sup>Present address: SUNY Upstate Medical University, Syracuse, NY 13210, USA

<sup>§</sup>Author for correspondence (e-mail: hirano@cshl.edu)

Accepted 1 March 2005

Journal of Cell Science 118, 2133-2141 Published by The Company of Biologists 2005  
doi:10.1242/jcs.02355

## Summary

Sister chromatid cohesion is essential for proper segregation of the genome in mitosis and meiosis. Central to this process is cohesin, a multi-protein complex conserved from yeast to human. Previous genetic studies in fungi have identified Pds5/BimD/Spo76 as an additional factor implicated in cohesion. Here we describe the biochemical and functional characterization of two Pds5-like proteins, Pds5A and Pds5B, from vertebrate cells. In HeLa cells, Pds5 proteins physically interact with cohesin and associate with chromatin in a cohesin-dependent manner. Depletion of the cohesin subunit Scc1 by RNA interference leads to the assembly of chromosomes with severe cohesion defects. A similar yet milder set of defects is observed in cells with reduced levels of Pds5A or Pds5B. In *Xenopus* egg extracts, mitotic chromosomes assembled in the absence of Pds5A and Pds5B display no discernible defects in arm cohesion, but centromeric cohesion is

apparently loosened. Unexpectedly, these chromosomes retain an unusually high level of cohesin. Thus, Pds5 proteins seem to affect the stable maintenance of cohesin-mediated cohesion and its efficient dissolution during mitosis. We propose that Pds5 proteins play both positive and negative roles in sister chromatid cohesion, possibly by directly modulating the dynamic interaction of cohesin with chromatin. This idea would explain why cells lacking Pds5 function display rather complex and diverse phenotypes in different organisms.

Supplementary material available online at  
<http://jcs.biologists.org/cgi/content/full/118/10/2133/DC1>

Key words: Sister chromatid cohesion, Chromosome assembly, RNA interference, *Xenopus*

## Introduction

Sister chromatid cohesion is a fundamental aspect of chromosome behavior that ensures the accurate inheritance of the genetic information in mitosis and meiosis (reviewed by Lee and Orr-Weaver, 2001; Nasmyth, 2001; Hirano, 2002). The central player of this process is cohesin, a conserved protein complex composed of a heterodimeric pair of structural maintenance of chromosomes (SMC) subunits, Smc1 and Smc3, and two additional non-SMC subunits, Scc3/SA and Scc1/Rad21. A native cohesin complex purified from human cells adopts a ring-shaped structure as revealed by electron microscopy (Anderson et al., 2002) consistent with the arrangement of cohesin subunits inferred from biochemical experiments in yeast (Haering et al., 2002). On the basis of these data and additional genetic experiments, it has been proposed that sister chromatids could be topologically trapped within the cohesin ring after DNA replication and cleavage of the Scc1 subunit in anaphase would open the ring to release the chromatids for separation (Gruber et al., 2003). Unlike *Saccharomyces cerevisiae*, the bulk of cohesin dissociates from chromatin during prophase in vertebrate cells (Losada et al., 1998; Losada et al., 2000; Waizenegger et al., 2000). This dissociation occurs without Scc1 cleavage and involves the action of the polo and aurora B kinases, yet its exact mechanism is not fully understood (Losada et al., 2002;

Sumara et al., 2002; Giménez-Abián et al., 2004). Furthermore, loading of cohesin on chromatin in G1 phase and the establishment of cohesion after passage of the replication fork probably involve opening and closing of the postulated cohesin ring (Haering and Nasmyth, 2003). One would therefore expect that a number of proteins participate in modulating the dynamic behavior of cohesin during the cell cycle.

Genetic screens in yeast and fungi have identified several classes of cohesion factors (Uhlmann, 2003). Among them is Pds5/BimD/Spo76, a protein conserved from yeast to human (Denison et al., 1993; Geck et al., 1999; van Heemst et al., 1999). Pds5 and cohesin have been shown to interact both genetically and physically (Holt and May, 1996; Hartman et al., 2000; Panizza et al., 2000; Sumara et al., 2000; Tanaka et al., 2001; Wang et al., 2002). In *S. cerevisiae*, Pds5 is essential for viability and is required to maintain cohesion (Panizza et al., 2000; Stead et al., 2003) and condensation (Hartman et al., 2000). In contrast, Pds5 is non-essential in *Schizosaccharomyces pombe*, and a  $\Delta pds5$  mutant shows cohesion defects only after prolonged arrest in G2/M (Tanaka et al., 2001; Wang et al., 2002). In *Sordaria* and *Aspergillus*, Spo76/BimD is important for both cohesion and condensation in mitosis and meiosis, but to a variable extent (van Heemst et al., 1999; van Heemst et al., 2001). Cohesion defects are also observed during meiosis in *Caenorhabditis elegans* *elv-*

14/*pds5* mutants whereas the mitotic phenotype is far less severe (Wang et al., 2003). Thus, different organisms seem to have substantially different requirements for Pds5 function, and the exact nature of the observed interaction between Pds5 and cohesin remains to be determined. Moreover, very little is known about the role of Pds5 proteins in vertebrates.

Here we report the biochemical and functional characterization of two Pds5 proteins, Pds5A and Pds5B, in human tissue culture cells and *Xenopus* egg cell-free extracts. In HeLa cells, a reduction in the levels of Pds5A or Pds5B by RNA interference (RNAi) leads to the assembly of abnormal mitotic chromosomes with partial defects in sister chromatid cohesion. In *Xenopus* egg extracts depleted of Pds5A and Pds5B, cohesion along chromosome arms appears normal but the altered localization of the inner centromere protein INCENP suggests that centromeric cohesion may be loosened. Unexpectedly, these chromosomes have an unusually high level of cohesin. In the light of these results, we propose that Pds5 participates in both stabilization and destabilization of cohesin-mediated cohesion.

## Materials and Methods

### Sequence analysis of human and *Xenopus* Pds5A and Pds5B

A full-length human Pds5A cDNA was assembled from two sequences present in the GenBank database, AB14548 and AK098331. The predicted product of 1337 amino acids was 40 residues longer at its N-terminus than that deduced by Kumar et al. (Kumar et al., 2004). Sequence alignment between our human and *Xenopus* Pds5A (see below) showed that the similarity is extended to the first 40 amino acids, indicating that our assignment of the initiation codon is more likely to be correct. Similarly, the predicted C-terminal end of the original sequence (hAS3) (Geck et al., 1999) was found not to be homologous to *Xenopus* Pds5B. We consider the recently updated version of this sequence, NM\_01532, as the authentic cDNA for human Pds5B. To clone *Xenopus* Pds5 cDNAs, a human cDNA fragment (part of AB14548) was amplified by PCR and used as a hybridization probe to screen an oocyte cDNA library as described (Losada et al., 2000). Positive clones fell into two classes. A full-length sequence was assembled from clones in the first class after amplifying the missing 5'-end sequence by nested PCR (*Xenopus* Pds5A). From the second class, a partial cDNA encoding a C-terminal fragment of 965 amino acids was determined (*Xenopus* Pds5B). These two sequences have been deposited in GenBank under accession numbers AY695731 and AY695732, respectively.

### Preparation of antibodies

Rabbit polyclonal antisera were raised against synthetic peptides corresponding to the C-terminal sequence of *Xenopus* Pds5A (TAKKTAQRQIDLHR), *Xenopus* Pds5B (VAPSTGRLRSACKR) and human Pds5B (VSTVNVRRRSAKRERR). The antibody against *Xenopus* Pds5A also recognizes human Pds5A. For a detailed list of all the other antibodies used in this study, see supplementary material.

### HeLa cell nuclear extracts

HeLa cell nuclear extracts were prepared in buffer B (20 mM K-HEPES, pH 8.0, 100 mM KCl, 2 mM MgCl<sub>2</sub>, 0.2 mM EDTA, 0.5 mM PMSF, 1 mM β-mercaptoethanol, 20% glycerol) as described previously (Losada et al., 2000). For immunoprecipitations, 2 μg affinity-purified antibody were added to 70 μl extract and incubated on ice for 2 hours. Immunoprecipitates were recovered on protein A-agarose beads (Invitrogen) and they were washed several times with buffer B before being analyzed by silver staining and immunoblotting.

### siRNA-mediated depletion of cohesin and Pds5 in HeLa cells

Exponentially growing HeLa cells were transfected twice with 100 nM oligo RNA duplexes (Dharmacon) using Oligofectamine (Invitrogen) at 0 and 24 hours (Elbashir et al., 2001). Control cells were transfected with a mixture containing no siRNA. Cells were seeded on wells containing poly-L-lysine-coated coverslips at 48 hours and they were processed for immunofluorescence at 72 hours. Total cell extracts were also prepared at this time to check the extent of depletion by immunoblotting. The sequences of the sense strand of the siRNA duplexes were: Scc1-1 5'-AUACCUUCUUGCAGACUGdTdT-3'; Scc1-2: 5'-GCACUACUACUUCUAACCUdTdT-3'; Pds5A-1, 5'-UU-CUCCUCAGGAACCCAdTdT-3'; Pds5A-2, 5'-GCUCCAUUAU-CUCCCCAUGdTdT-3'; Pds5B-1, 5'-GCUCCUUACACAUCCCC-UGdTdT-3'; Pds5B-2, 5'-GAGACGACUCUGAUCUUGdTdT-3'. Although a similar set of defects was observed after transfection with Scc1-1 or Scc1-2, their frequency was slightly higher with Scc1-1, consistent with a more efficient depletion of Scc1 as judged by immunoblotting. The two oligonucleotides used for Pds5A and Pds5B depletion produced essentially similar results.

### Immunofluorescence

HeLa cells grown on coverslips were fixed with 2% paraformaldehyde in PBS pH 7.4, for 15 minutes and permeabilized in 0.5% Triton X-100 in PBS for 5 minutes at room temperature. For the experiments shown in Fig. 3B,C, cells were pre-extracted with 0.5% Triton X-100 in CSK buffer (10 mM PIPES, pH 7.0, 100 mM NaCl, 3 mM MgCl<sub>2</sub> and 300 mM sucrose) for 5 minutes before fixation. For the staining shown in Fig. 4A, cells were incubated in 60 mM KCl at room temperature for 30 minutes before fixation. Metaphase chromosome spreads (Fig. 4C) were prepared as described (Ono et al., 2003), except that colcemid was added to the culture medium 2 hours before harvesting cells. Immunolabeling was carried out as described (Losada et al., 1998). Double labeling with anti-CAP-H2 and Alexa 488-conjugated anti-CAP-G (Fig. 7A) or with anti-CENP-E and Alexa 488-conjugated anti-INCENP (Fig. 7C) was done as described (Ono et al., 2003).

### *Xenopus* egg extracts

Low-speed supernatants (LSS) and high-speed supernatants (HSS) of *Xenopus* eggs were prepared in XBE2 (10 mM K-HEPES, pH 7.7, 100 mM KCl, 2 mM MgCl<sub>2</sub>, 0.1 mM CaCl<sub>2</sub>, 5 mM EGTA and 50 mM sucrose) as described previously (Losada et al., 1998; Losada et al., 2002). For immunodepletion, 50 μl of LSS were incubated on ice three times for 40 minutes with 25 μl of Dynabeads Protein A (Dyna) bound to 6 μg of anti-Pds5A or Pds5B (single depletion) or 4 μg each of anti-Pds5A and Pds5B (Pds5 double depletion) or 2.5 μg anti-Smc1 and 4 μg anti-Smc3 (cohesin depletion) or 8 μg non-immune rabbit IgG (mock depletion). For immunoprecipitations, 5 μg of affinity-purified antibody were added to 100 μl HSS, and the reactions were processed as described above using XBE2 instead of buffer B for the washes.

### Assembly of *Xenopus* chromatin and chromosomes

*Xenopus* sperm chromatin was added to interphase HSS (3000 nuclei/μl extract) or LSS (1000 nuclei/μl). After incubation at 22°C for 2 hours, the extract was converted into a mitotic state by adding half a volume of cytostatic factor (CSF)-arrested extracts. For biochemical analysis, the reaction mixtures were diluted fivefold (in the case of HSS) or tenfold (in the case of LSS) with XBE2 containing 0.25% Triton X-100, and chromatin fractions were isolated by centrifugation as described previously (Losada et al., 1998). For morphological analyses, 10 μl of the reaction mixtures were diluted with 90 μl of 2% formaldehyde in XBE2 containing 0.25% Triton X-100, spun over coverslips and processed for immunofluorescence as described above.

## Results

### Two Pds5-like proteins in human and *Xenopus*

The human genome contains two distinct genes that encode polypeptides showing similarity to Pds5/BimD/Spo76 previously described in fungi. One encodes a polypeptide of 1337 amino acids with a calculated molecular mass of 150 kDa. The second one was originally identified as a gene (*AS3*) whose expression was upregulated upon androgen-induced G1 arrest (Geck et al., 1999). Its gene product is 1447 amino acids long and has a predicted molecular mass of 165 kDa. Sumara and co-workers (Sumara et al., 2000) reported a partial biochemical characterization of the first polypeptide (which they called hPds5) but not of the second one. In the current study, we refer to the 150- and 165-kDa polypeptides as Pds5A and Pds5B, respectively. We have also isolated cDNA clones encoding Pds5A and Pds5B from a *Xenopus laevis* oocyte library (Fig. 1). Pds5A and Pds5B are similar to each other in their N-terminal 1140 amino acid domain (~72% identity). This region contains two clusters of HEAT repeats, a motif found in a number of proteins involved in chromosome biology (Neuwald and Hirano, 2000; Panizza et al., 2000). The C-termini of the two polypeptides are highly divergent, and five consensus sites for Cdk phosphorylation are present in this region of Pds5B but not of Pds5A.

### Physical interaction of Pds5A and Pds5B with cohesin in HeLa cell nuclear extracts

To characterize Pds5A and Pds5B biochemically, we raised antibodies against synthetic peptides corresponding to their C-termini. Each antibody recognized a polypeptide of the expected molecular weight in HeLa cell nuclear extracts (Fig. 2A). Immunoprecipitation reactions analyzed by silver staining (Fig. 2B) and immunoblotting (Fig. 2C) demonstrated that both Pds5A and Pds5B interact with cohesin in a highly specific manner. We have previously reported that there are two distinct cohesin complexes in HeLa cells (cohesin<sup>SA1</sup> and cohesin<sup>SA2</sup>) that contain different versions of the SA subunit, SA1 and SA2, respectively (Losada et al., 2000). In addition to Smc1, Smc3 and Scc1, both anti-Pds5A and anti-Pds5B precipitated SA1 and SA2 (Fig. 2C, two lower panels), suggesting that no exclusive association exists between one of the Pds5 proteins and one of the cohesin complexes. We also found that Pds5A was not present in the anti-Pds5B precipitate or vice versa (Fig. 2C, two upper panels). As judged by the amount of protein remaining in the extracts after immunoprecipitation (data not shown), we estimate that more than half of Pds5A and Pds5B is associated with cohesin. Conversely, ~20-30% of the total cohesin present in the extract is associated with Pds5A or Pds5B. When the anti-

Smc3 precipitates were washed with buffers of increasing ionic strength, we observed a decrease in the recovery of both Pds5 proteins, but not of Scc1 (Fig. 2D). Furthermore, the interaction between Pds5 and cohesin was not stably maintained during fractionation of HeLa cell nuclear extracts by sucrose gradient centrifugation (data not shown) (Sumara et al., 2000). Thus, despite their specific interaction with cohesin, the Pds5 proteins should not be considered stoichiometric, inherent subunits of the cohesin complex in HeLa cells.

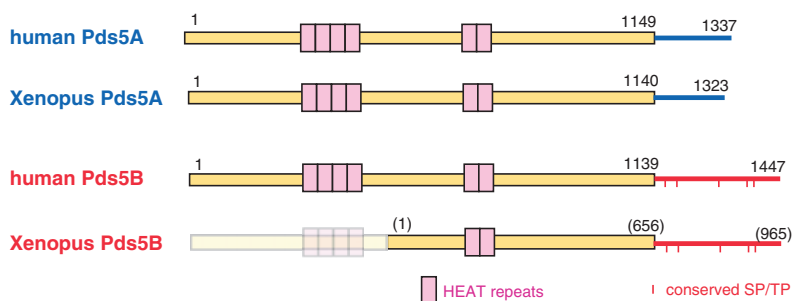
### Association of Pds5A with chromatin requires functional cohesin in HeLa cells

To test the functional significance of the interactions detected between Pds5 and cohesin, we designed small interfering RNAs (siRNAs) specific to Pds5A and Pds5B, as well as the cohesin subunit Scc1. Transfection of HeLa cells with each of the siRNA duplexes substantially decreased the level of the target protein without affecting the other two, as judged by immunoblotting of whole cell extracts (Fig. 3A, three upper panels). None of the treatments affected the levels of Smc1, Smc3 or an unrelated protein such as Orc2, a subunit of the origin recognition complex (Fig. 3A, two lower panels). To examine the association of the cohesin complex with chromatin after siRNA treatment, the cells were pre-extracted with detergent, fixed and analyzed by immunofluorescence with anti-Smc3. We found that the level of chromatin-bound Smc3 was drastically reduced in Scc1 siRNA-treated cells compared with control cells. Such a reduction was not observed in cells transfected with Pds5A or Pds5B siRNAs (Fig. 3B). This result suggests that Scc1, but neither Pds5A nor Pds5B, is required for the stable association of Smc3 with chromatin. Immunofluorescent labeling of HeLa cells showed that Pds5A, like cohesin, localized to the interphase nucleus (Fig. S1 in supplementary material). As expected, the nuclear signal of Pds5A was greatly reduced in Pds5A siRNA-treated cells compared with control cells, but it was unchanged in cells treated with Pds5B siRNA (Fig. 3C). Importantly, we found that the chromatin-bound population of Pds5A was reduced in cells treated with Scc1 siRNA, indicating that a functional cohesin complex is required for stable association of Pds5A with chromatin. Although the quality of the currently available anti-Pds5B did not allow us to determine whether the association of Pds5B with chromatin also depends on cohesin, this is indeed the case in *Xenopus* egg extracts (see below).

### Cohesion defects in HeLa cells with reduced levels of cohesin and Pds5

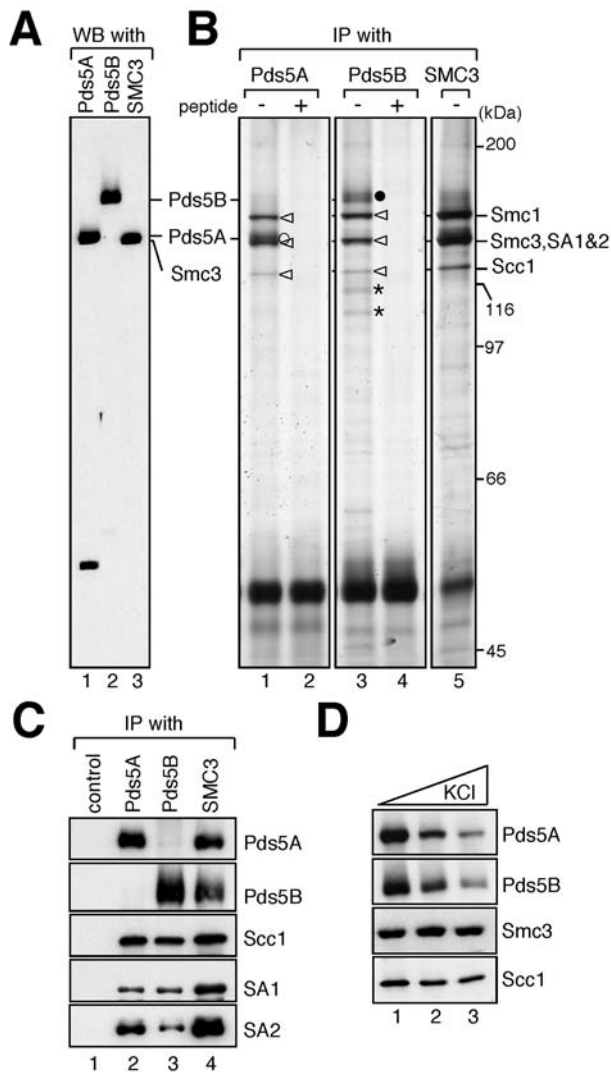
We next examined the morphology of mitotic chromosomes

**Fig. 1.** Schematic representation of the primary structures of Pds5A and Pds5B from human and *Xenopus*. The yellow bars indicate the 'core' region conserved between Pds5A and Pds5B, which contains multiple HEAT repeats (shown in magenta). The C-termini of Pds5A (blue line) and Pds5B (red line) display little similarity. Consensus sites for Cdk phosphorylation are clustered in the C-terminal domain of Pds5B (indicated by thin, vertical red lines) but not of Pds5A. The shadowed N-terminal region of *Xenopus* Pds5B has not yet been cloned.



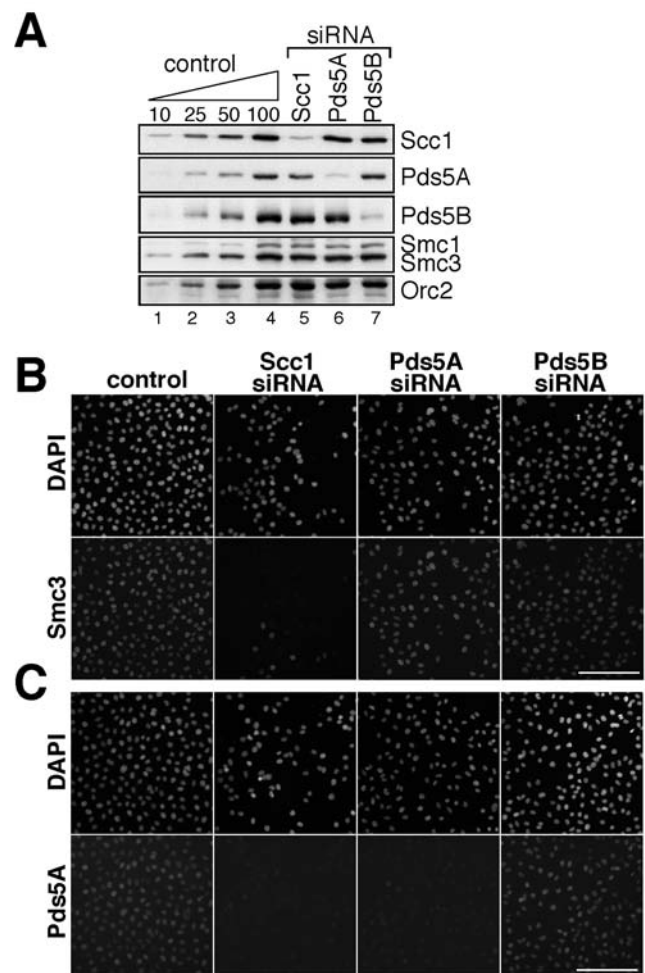


assembled in the cells treated with siRNAs specific to Scc1, Pds5A and Pds5B. Cells were subject to a hypotonic treatment, fixed and labeled with antibodies against the condensin subunit CAP-E/Smc2 and the mitotic protein

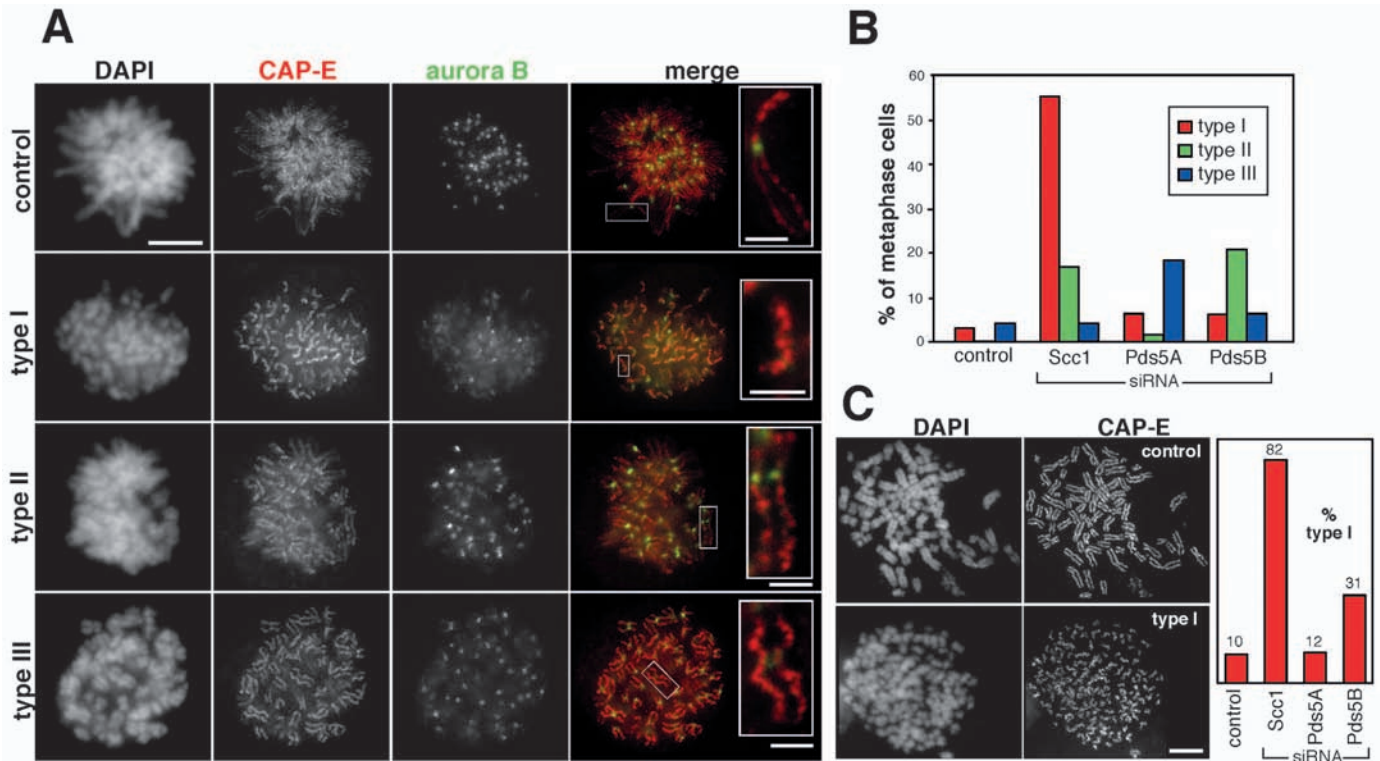


**Fig. 2.** Pds5A and Pds5B associate with cohesin in HeLa cell nuclear extracts. (A) Immunoblot of HeLa cell nuclear extracts with antibodies against Pds5A (lane 1), Pds5B (lane 2) and the cohesin subunit Smc3 (lane 3). (B) The same antibodies were used in immunoprecipitations carried out on HeLa cell nuclear extracts in the absence (lanes 1, 3 and 5) or presence (lanes 2 and 4) of the corresponding antigen peptide (0.5 mg/ml). The immunoprecipitates were fractionated in a 7.5% SDS-polyacrylamide gel and stained with silver. The positions of cohesin subunits, Pds5A and Pds5B are marked by arrowheads, a white circle and a black circle respectively, in lanes 1 and 3. The two polypeptides of 105 and 110 kDa present in the Pds5B precipitate (asterisks in lane 3) are likely to be non-specific because neither of them was detectable when a different antibody against Pds5B was used. (C) Immunoblot analysis of the immunoprecipitates obtained with non-immune rabbit IgG as control (lane 1), anti-Pds5A (lane 2), anti-Pds5B (lane 3) or anti-Smc3 (lane 4). (D) The immunoprecipitates obtained with anti-Smc3 were washed with a buffer containing increasing concentrations of KCl (0.2 M, 0.4 M and 0.8 M, lanes 1-3) before being analyzed by immunoblotting.

kinase aurora B. In control metaphase cells, the axes of the sister chromatids, labeled with anti-CAP-E, were paired along their entire length, and aurora B localized to a single dot at the primary constriction of each chromosome (Fig. 4A, control). In cells transfected with siRNAs, we observed abnormal phenotypes that could be classified into three groups (Fig. 4A, types I to III). The 'type I' phenotype was the most striking, and consisted of chromosomes in which cohesion between the two sister chromatids was lost. The resulting single chromatids were usually shorter and thicker, and presented a wavy axis. The aurora B signal was no longer concentrated at the primary constriction but spread along the chromatid arm. In the 'type II' phenotype, chromosomes exhibited loosely paired sister chromatids, and the aurora B signal was split into two dots at the primary constriction,



**Fig. 3.** Association of Pds5A with chromatin requires functional cohesin in HeLa cells. (A) HeLa cells were transfected with siRNAs specific to the cohesin subunit Scc1, Pds5A or Pds5B or mock-transfected with buffer as control. To estimate the extent of depletion, aliquots of siRNA-treated cell extracts were analyzed by immunoblotting (lanes 5-7) alongside increasing amounts of a control cell extract (expressed as percentage, lanes 1-4). The levels of Orc2 were analyzed as a loading control. (B,C) HeLa cells transfected as in A were pre-extracted with detergent before fixation and stained with DAPI and anti-Smc3 (B) or anti-Pds5A (C). All images were acquired over the same exposure time. Bar, 50  $\mu$ m.



**Fig. 4.** Cohesion defects in cells with reduced levels of cohesin or Pds5 proteins. (A) HeLa cells grown on coverslips that had been transfected with no siRNA (control) or with siRNAs specific to Sccl, Pds5A or Pds5B were incubated in 60 mM KCl for 30 minutes, fixed and stained with DAPI, anti-condensin (CAP-E/Smc2) and anti-aurora B. In the 'merge' panels, CAP-E and aurora B signals appear in red and green, respectively. Representative examples of a normal metaphase cell (control), and of the different types of abnormalities found among the cells treated with siRNA (type I, type II and type III). (B) Quantification of the defects described in A. The total number of metaphase cells scored was 283 (control), 450 (Sccl siRNA), 260 (Pds5A siRNA), and 243 (Pds5B siRNA). (C) Examples of metaphase chromosome spreads prepared from siRNA-transfected cells and co-stained with DAPI and anti-CAP-E. The top panels show control chromosomes and the bottom panels show chromosomes with unpaired chromatids (type I). The frequency of this latter phenotype is also shown. The total number of metaphase cells scored was 269 (control), 279 (Sccl siRNA), 227 (Pds5A siRNA), and 225 (Pds5B siRNA). Bar, 5  $\mu$ m (A,C); 2  $\mu$ m (insets in A).

suggesting a defect in centromeric cohesion. In the chromosomes categorized as 'type III', centromeric cohesion was apparently normal, but sister chromatids were shorter and more separated and displayed a wavy axis. More than half of the metaphase cells transfected with Sccl siRNA showed the type I phenotype (Fig. 4B). The type II and type III phenotypes were more prevalent among the cells transfected with Pds5B and Pds5A siRNAs respectively, and only small fraction of cells showing the type I phenotype were found in these cultures. However, when metaphase chromosome spreads were prepared from colcemid-arrested cells, the fraction of cells with single chromatids (type I) increased in Sccl siRNA- and Pds5B siRNA-treated cells (Fig. 4C). Taken together, these results suggest that the human Pds5 proteins contribute to the proper assembly of metaphase chromosomes with tightly paired sister chromatids, and further imply that there may be some division of labor between Pds5A and Pds5B in arm and centromeric cohesion, respectively.

#### Chromosome alignment defects in mitotic cells with reduced levels of cohesin and Pds5 proteins

Consistent with the observed defects in chromosome assembly, we also found a number of defects in chromosome

alignment and segregation in Sccl-, Pds5A- and Pds5B-deficient cells (Fig. 5). In most control metaphase cells, all chromosomes become bi-oriented at the spindle equator, forming a tight metaphase plate (Fig. 5a). In contrast, a large proportion of the mitotic cell population in the Sccl siRNA-treated samples corresponded to prometaphase cells with striking chromosome alignment defects and multipolar spindles (Fig. 5b) or pseudo-anaphase cells with elongated spindles and prematurely separated sister chromatids (Fig. 5c). A two- to threefold increase of the mitotic index was observed in these samples. HeLa cells treated with Pds5A or Pds5B siRNAs showed similar defects, albeit to a lesser extent. The most commonly observed abnormality was a metaphase cell with a bipolar spindle in which a number of chromosomes (from one to five) had failed to congress to the metaphase plate (Fig. 5d). In addition, more severely disorganized mitotic figures with abnormally condensed chromosomes were found after Pds5 depletion (Fig. 5e). Whether these abnormal chromosomes are the primary consequence of the lack of Pds5 function or a secondary effect of a prolonged metaphase arrest remains to be determined. No major variation of the mitotic index was observed in Pds5A or Pds5B siRNA-treated cell cultures compared to control.

Behavior of Pds5 proteins in *Xenopus* egg extracts

To gain more insight into the function of vertebrate Pds5 proteins, we turned to the *Xenopus* egg cell-free system that has proved to be powerful in the study of chromosome dynamics (e.g. Losada et al., 2002). Antibodies against Pds5A and Pds5B efficiently precipitated the corresponding protein, but not the other, from *Xenopus* egg extracts, as judged by immunoblot analysis of the immunoprecipitates (Fig. 6A). Both proteins are in very low abundance in these extracts, as they were hardly detectable by silver staining of the immunoprecipitated fractions (data not shown). The co-precipitation of Pds5 with cohesin subunits was far less prominent in *Xenopus* egg extracts than in HeLa nuclear extracts (Fig. 6A, compare with Fig. 2C). Consistently,

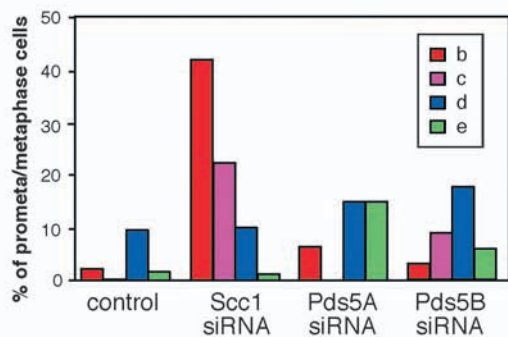
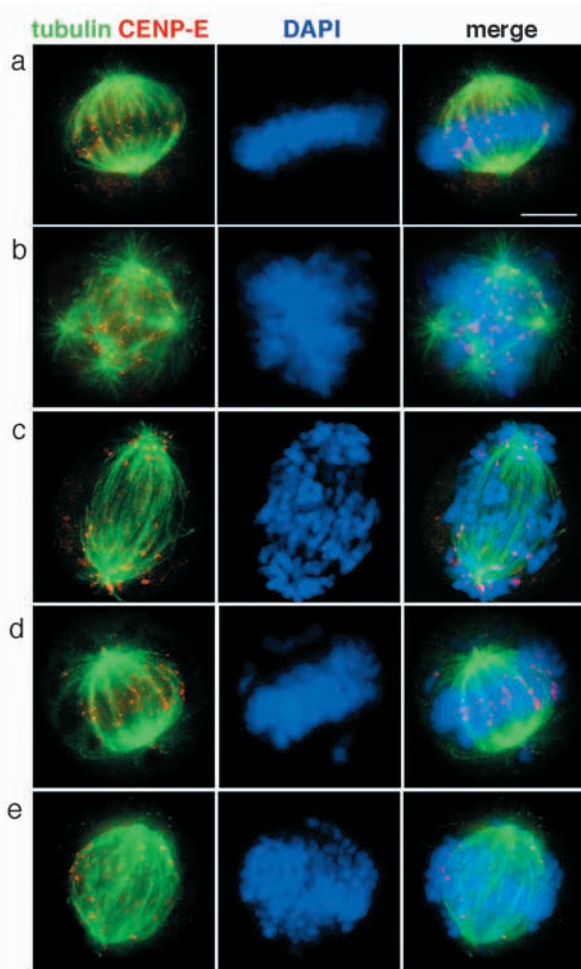
immunodepletion of cohesin barely affected the amount of Pds5A or Pds5B present in the extract, and vice versa (Fig. 6C, lanes 1-3, and data not shown). These results indicate that Pds5 proteins are not stored in the egg cytoplasm as part of a stable complex containing cohesin subunits.

To examine the chromatin binding properties of Pds5 proteins in the cell-free extracts, chromatin was first assembled in an interphase extract, and then converted to mitotic chromosomes. Chromatin fractions were isolated in the course of the reaction and analyzed by immunoblotting. We observed progressive loading of Pds5B on interphase chromatin and substantial dissociation upon entry into mitosis, coincident with the association of condensin. This behavior was essentially identical to that of the cohesin subunit Scc1 (Fig. 6B, three bottom panels). Unlike Pds5B, only a small population of Pds5A was recovered on chromatin during interphase and no clear dissociation was observed in mitosis (Fig. 6B, top panel).

To test the interdependency of Pds5B and cohesin in their association with chromatin, interphase chromatin was assembled in extracts that had been mock-depleted or depleted of Pds5B or cohesin and was isolated and analyzed by immunoblotting (Fig. 6C). The loading of Pds5B on chromatin was severely compromised in the cohesin-depleted extract whereas a normal level of cohesin bound to chromatin in the absence of Pds5B. Similarly, depletion of Pds5A or simultaneous depletion of Pds5A and Pds5B had little effect in the binding of cohesin to interphase chromatin (Fig. S2 in supplementary material and data not shown). Conflicting observations reported in two previous studies made uncertain whether this was the case in *S. cerevisiae* (Hartman et al., 2000; Panizza et al., 2000). Our results in *Xenopus* egg extracts and HeLa cells showing that cohesin loading does not depend on Pds5 are consistent with those from Hartman et al. (Hartman et al., 2000) as well as with more recent results from studies in *S. pombe* (Tanaka et al., 2001; Wang et al., 2002).

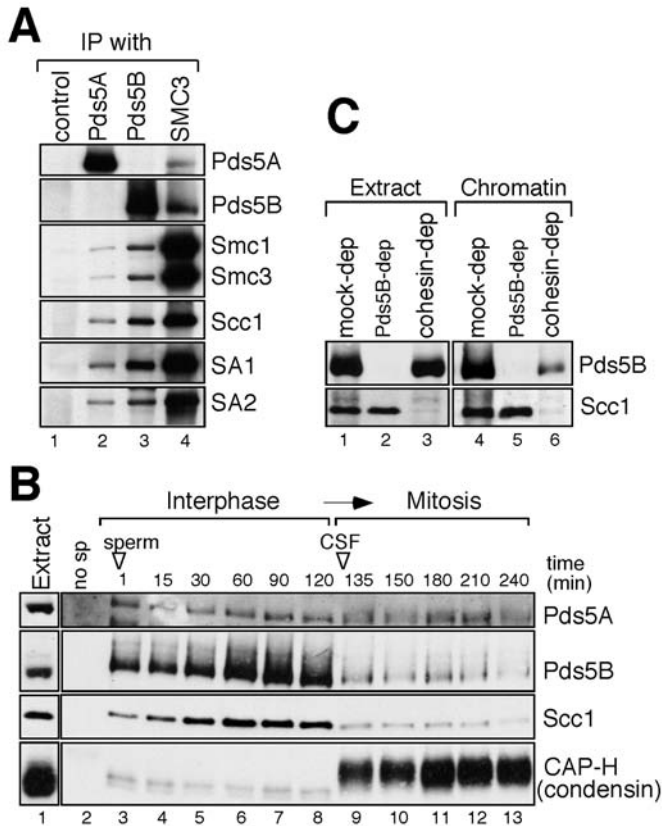
Depletion of Pds5 proteins disturbs cohesin regulation in *Xenopus* egg extracts

To test whether Pds5 proteins are important for sister chromatid cohesion in *Xenopus* egg extracts, we performed a cohesion assay (Losada et al., 1998). Metaphase-like chromosomes were assembled in extracts that had been mock depleted, depleted of cohesin or depleted of both Pds5A and Pds5B. The efficiency of each depletion was higher than 95% in all cases (Fig. S2A in supplementary material and data not shown). The chromosomes were isolated from each extract and



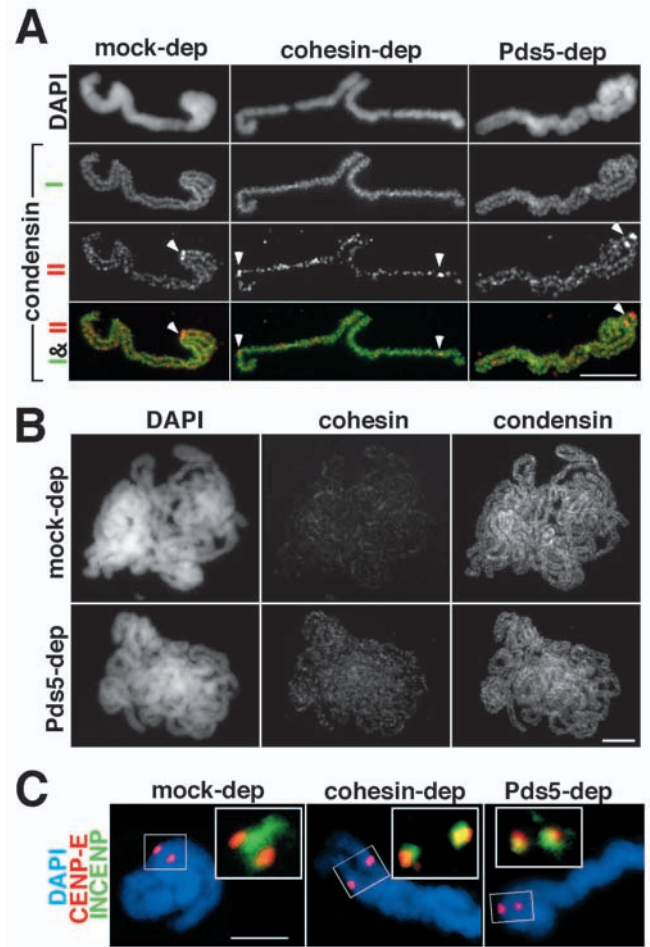
**Fig. 5.** Chromosome alignment and segregation defects in HeLa cells with reduced levels of cohesin or Pds5 proteins. HeLa cells that had been mock-transfected (control) or transfected with siRNAs specific for Scc1, Pds5A or Pds5B were fixed and labeled with antibodies against  $\alpha$ -tubulin (green) and CENP-E (red). DNA was stained with DAPI (blue). Representative examples of a normal metaphase cell (a), and of the different types of abnormalities found among the cells treated with siRNA (b-e). The frequency of the defects among the population of prometaphase/metaphase cells in the different cultures is shown in the graph below the images. The number of cells scored was 284 (control), 461 (Scc1 siRNA), 269 (Pds5A siRNA) and 242 (Pds5B siRNA). Bar, 5  $\mu$ m.





**Fig. 6.** Characterization of Pds5A and Pds5B in *Xenopus* egg extracts. (A) Pds5A (lane 2) and Pds5B (lane 3) were immunoprecipitated from *Xenopus* HSS with the corresponding antibodies. Cohesin complexes were immunoprecipitated in parallel reactions with anti-Smc3 (lane 4), and non-immune rabbit IgG was used as control (lane 1). The immunoprecipitates were analyzed by immunoblotting. (B) Sperm chromatin was incubated in interphase LSS to assemble interphase nuclei and then half a volume of CSF (mitotic) LSS was added to trigger entry into mitosis. Chromatin fractions were isolated at the times indicated (lanes 3-13), and analyzed by immunoblotting. A sample from a mock assembly reaction without sperm chromatin (lane 2) and an aliquot of the interphase extract were also included (lane 1). (C) Interphase chromatin was assembled in interphase LSS that had been immunodepleted with non-immune IgG (lanes 1 and 4; mock-dep), anti-Pds5B (lanes 2 and 5; Pds5B-dep) or a mixture of anti-Smc1 and anti-Smc3 (lanes 3 and 6; cohesin-dep). Aliquots of each extract (lanes 1-3) and the corresponding chromatin fractions (lanes 4-6) were analyzed by immunoblotting.

labeled with antibodies against condensins I and II (Ono et al., 2003). Although many of the chromosomes assembled in a cohesin-depleted extract showed dramatic defects in sister chromatid cohesion both along the arms and at the centromeric region (Fig. 7A, cohesin-dep), no apparent defects were observed in those assembled in the extract depleted of Pds5A and Pds5B (Fig. 7A, Pds5-dep). A subpopulation of condensin II was enriched at the centromeric region of the *in vitro* assembled chromosomes, as has been recently shown in HeLa cell chromosomes (Ono et al., 2004), and this enrichment was not compromised in the absence of cohesin or Pds5 (Fig. 7A, two lower rows). Despite their apparently normal morphology, chromosomes assembled in the Pds5-depleted extract retained



**Fig. 7.** Morphological analysis of chromosomes assembled in the absence of Pds5A and Pds5B. (A) Representative images of individual chromosomes assembled in mock-depleted (left), cohesin-depleted (center) and Pds5-depleted (both Pds5A and Pds5B) extracts (right) and stained with DAPI, anti-CAP-G (condensin I), and anti-CAP-H2 (condensin II). The signals of condensin I and II appear in green and red, respectively, in the merged images shown in the bottom panels. The arrowheads indicate the enrichment of CAP-H2 at the centromeric region. (B) Mitotic chromosomes were assembled in extracts that had been mock-depleted (top) or depleted of Pds5A and Pds5B (bottom) as in A, and co-stained with DAPI, anti-SA1 (cohesin) and anti-CAP-E (condensin). A mass of entangled chromosomes is shown. (C) Mitotic chromosomes assembled in extracts that had been mock-depleted (left), depleted of cohesin (middle) or depleted of both Pds5A and Pds5B (right) were co-stained with anti-INCENP (green), anti-CENP-E (red) and DAPI (blue). Merged images of DAPI and CENP-E (whole chromosome) or CENP-E and INCENP (inset) are shown. To better compare the organization of the pericentromeric region of these chromosomes, we show a chromosome from the cohesin-depleted sample with a less severe cohesion defect than the chromosome presented in Fig. 6A, center. The defect is nonetheless obvious, as judged by the increased separation between the sister chromatids in the upper part of the chromosome as well as between the sister kinetochores. Bar, 5  $\mu$ m.

an abnormally high level of cohesin, as judged both by immunolabeling with anti-SA1 (Fig. 7B) and by immunoblotting with anti-Scc1 (Fig. S2B in supplementary material).

Previous reports have shown that the distribution of the chromosome passenger protein INCENP changes upon depletion of functional cohesin in chicken and *Drosophila* cells (Sonoda et al., 2001; Vass et al., 2003). We wished to test whether this might also be the case in *Xenopus* egg extracts. In the chromosomes with tightly paired chromatids assembled in mock-depleted extracts, INCENP staining was detected between the sister chromatids throughout the pericentromeric region, flanked by the signals of kinetochore protein CENP-E (Fig. 7C, left). In chromosomes assembled in cohesin-depleted extracts, however, the INCENP signal was no longer present in the inner pericentromeric region, being instead restricted to the kinetochores. This was the case even in a population of cohesin-depleted chromosomes that showed a relatively mild cohesion defect (Fig. 7C, center). The same localization of INCENP was observed in many of the chromosomes isolated from extracts depleted of Pds5A and Pds5B (Fig. 7C, right). Thus, the Pds5-depleted chromosomes may have a mild defect in centromeric cohesion that is not readily detectable with our standard cohesion assay.

## Discussion

Members of the Pds5/BimD/Spo76 family of proteins are present in most eukaryotic organisms and their genetic studies have been described in fungi (Denison et al., 1993; van Heemst et al., 1999; Hartman et al., 2000; Panizza et al., 2000; Tanaka et al., 2001; van Heemst et al., 2001; Wang et al., 2002; Stead et al., 2003) and *C. elegans* (Wang et al., 2003). Vertebrate cells have two different Pds5-like proteins, and the initial biochemical characterization of only one of them has been reported before (Sumara et al., 2000). The current paper reports a more extensive characterization of Pds5A and Pds5B in both human and *Xenopus*, and more importantly, it describes for the first time the defects observed after abolishing Pds5 function in cells and cell-free extracts.

The cell cycle-regulated localization of Pds5A and Pds5B in HeLa cells is essentially identical to that of cohesin (see Fig. S1 in supplementary material) (Losada et al., 2000; Sumara et al., 2000). In nuclear extracts, a specific interaction between each Pds5 protein and cohesin is readily detectable by co-immunoprecipitation. We also show here that association of Pds5A, and most likely Pds5B, with chromatin is dependent on functional cohesin in HeLa cells. Although cohesin can be loaded on chromatin in cells treated with Pds5A or Pds5B siRNA, the morphology of mitotic chromosomes in these cells is compromised. Some chromosomes display loosened cohesion at both the centromeric and arm regions, whereas others show separated arms with wavy chromatid axes but no major impairment of centromeric cohesion. A similar, yet more severe phenotype was observed in cells depleted of the cohesin subunit Scc1. In this case, more than half of the mitotic cells show completely unpaired chromatids, a phenotype also found in human cells expressing a dominant-negative version of Scc1 (Hoque and Ishikawa, 2002) and in *Drosophila* cells depleted of Scc1/Rad21 by RNAi (Vass et al., 2003). The milder phenotypes found in Pds5A- or Pds5B-deficient cells could be due to incomplete depletion of each of the target proteins by RNAi treatment. Alternatively, Pds5A and Pds5B may have redundant functions, and one may be able to substitute for the other. As we have been unable to find experimental conditions that allow the

simultaneous, efficient reduction of the two Pds5 proteins in HeLa cells, this possibility remains open.

By quantitative immunoprecipitation analysis, we estimate the relative abundance of Pds5A or Pds5B to cohesin to be ~1:20 in *Xenopus* egg extracts, a value substantially smaller than the ~1:3 or 1:4 ratio estimated in HeLa cell nuclear extracts. Furthermore, only a minor population of Pds5 proteins is found associated with cohesin in the egg extracts. Although other interpretations are possible, these two observations suggest that the function of Pds5 proteins may be less important in the embryo than in somatic cells. Consistently, in the embryonic extracts, no prominent defect in arm cohesion is observed in the absence of Pds5A and Pds5B. It is nevertheless important to emphasize that the association of Pds5B with chromatin depends on cohesin in *Xenopus* egg extracts, and that centromeric cohesion appears to be loosened in chromosomes from Pds5-depleted extracts, as judged by delocalization of INCENP. The finding of an abnormal level of cohesin on these chromosomes was somewhat unexpected. Given the proposed role of Pds5 in cohesion maintenance (e.g. Stead et al., 2003), one would anticipate that the association of cohesin with chromatin would be destabilized rather than stabilized in the absence of Pds5 function. We speculate that Pds5 may facilitate conformational changes of cohesin and thereby regulate its behavior both positively and negatively. Such dual functions of Pds5 have been hinted at by a genetic study in *S. pombe* showing that Pds5 not only contributes to the maintenance of cohesion, but also acts as an inhibitor of its establishment (Tanaka et al., 2001). In *Xenopus* egg extracts, Pds5B is phosphorylated in a mitosis-specific manner (see Fig. S3 in supplementary material). This modification could render cohesin accessible to the dissociation machinery or prevent re-association of the cohesin complexes that had just been removed from chromatin (Losada et al., 2000). Recent results in yeast suggest that Pds5 is regulated by sumoylation (Stead et al., 2003). So far we have been unable to show convincing sumoylation of either of the two Pds5 proteins in HeLa or *Xenopus* extracts. However, it is conceivable that sumoylation of vertebrate Pds5 is restricted to a very small population, for instance present at centromeres of mitotic chromosomes, making its detection very difficult.

How might Pds5 proteins regulate the action of cohesin at a mechanistic level? It is interesting to note that this class of proteins contains HEAT repeats (Neuwald and Hirano, 2000; Panizza et al., 2000), which are also shared by the cohesin loading factor Scc2 and some of the non-SMC subunits of condensins (Ono et al., 2003). It is possible that the HEAT motifs act as regulators of the SMC ATPase (Kimura and Hirano, 2000) and thereby modulate the opening and closing of the ring- or V-shaped SMC molecules (Arumugam et al., 2003; Weitzer et al., 2003). Alternatively, a superhelical scaffolding structure formed by HEAT-repeat domains (Kobe and Kajava, 2000) may promote protein-protein interactions between neighboring cohesin complexes. It has recently been suggested that, after being loaded onto chromatin, cohesin relocates and accumulates at sites of convergent transcription (Glynn et al., 2004; Lengronne et al., 2004). In this scenario, Pds5 could facilitate the sliding of cohesin rings along the chromatids and/or stabilize their clustering. The clusters would contribute to the establishment of robust cohesion, and also to its efficient dissolution in subsequent mitosis. Pds5-mediated stabilization of cohesion is probably more important for organisms with small



chromosomes and little non-coding DNA (e.g. *S. cerevisiae*) in order to achieve strong arm cohesion despite active transcription throughout the cell cycle. In vertebrate cells, stable cohesion in the large blocks of centromeric heterochromatin could be facilitated by a Pds5-independent mechanism, such as that involving the RNAi machinery (Fukagawa et al., 2004). Although purely speculative, this model may help us understand the diverse requirements for Pds5 function in different organisms as well as devise new strategies to dissect the molecular mechanism of action of this puzzling class of cohesion factor.

We are grateful to T. J. Yen and B. Stillman for the gift of anti-CENP-E and anti-Orc2, respectively, to M. Hirano for technical assistance and to T. Ono for advice regarding RNAi and cytospin. We also wish to thank J. Méndez and P. Gillespie for critically reading the manuscript. A.L. is a Special Fellow of the Leukemia and Lymphoma Society. This work was supported by a grant from the National Institutes of Health to T.H. (GM63545).

## References

- Anderson, D. E., Losada, A., Erickson, H. P. and Hirano, T. (2002). Condensin and cohesin display different arm conformations with characteristic hinge angles. *J. Cell Biol.* **156**, 419-424.
- Arumugam, P., Gruber, S., Tanaka, K., Haering, C. H., Mechtler, K. and Nasmyth, K. (2003). ATP hydrolysis is required for cohesin's association with chromosomes. *Curr. Biol.* **13**, 1941-1953.
- Denison, S. H., Kafer, E. and May, G. S. (1993). Mutation in the bimD gene of *Aspergillus nidulans* confers a conditional mitotic block and sensitivity to DNA damaging agents. *Genetics* **134**, 1085-1096.
- Elbshir, S. M., Harborth, J., Lendeckel, W., Yalcin, A., Weber, K. and Tuschl, T. (2001). Duplexes of 21-nucleotide RNAs mediate RNA interference in cultured mammalian cells. *Nature* **411**, 494-498.
- Fukagawa, T., Nogami, M., Yoshikawa, M., Ikeno, M., Okazaki, T., Takami, Y., Nakayama, T. and Oshimura, M. (2004). Dicer is essential for formation of the heterochromatin structure in vertebrate cells. *Nat. Cell Biol.* **6**, 784-791.
- Geck, P., Szelei, J., Jimenez, J., Sonnenschein, C. and Soto, A. M. (1999). Early gene expression during androgen-induced inhibition of proliferation of prostate cancer cells: a new suppressor candidate on chromosome 13, in the BRCA2-Rb locus. *J. Steroid Biochem. Mol. Biol.* **68**, 41-45.
- Giménez-Abián, J. F., Sumara, I., Hirota, T., Hauf, S., Gerlich, D., de la Torre, C., Ellenberg, J. and Peters, J. M. (2004). Regulation of sister chromatid cohesion between chromosome arms. *Curr. Biol.* **14**, 1187-1193.
- Glynn, E. F., Megee, P. C., Yu, H. G., Mistrot, C., Unal, E., Koshland, D. E., DeRisi, J. L. and Gerton, J. L. (2004). Genome-wide mapping of the cohesin complex in the yeast *Saccharomyces cerevisiae*. *PLoS Biol.* **2**, E259.
- Gruber, S., Haering, C. H. and Nasmyth, K. (2003). Chromosomal cohesin forms a ring. *Cell* **112**, 765-777.
- Haering, C. H. and Nasmyth, K. (2003). Building and breaking bridges between sister chromatids. *BioEssays* **25**, 1178-1191.
- Haering, C. H., Lowe, J., Hochwagen, A. and Nasmyth, K. (2002). Molecular architecture of SMC proteins and the yeast cohesin complex. *Mol. Cell* **9**, 773-788.
- Hartman, T., Stead, K., Koshland, D. and Guacci, V. (2000). Pds5p is an essential chromosomal protein required for both sister chromatid cohesion and condensation in *Saccharomyces cerevisiae*. *J. Cell Biol.* **151**, 613-626.
- Hirano, T. (2002). The ABCs of SMC proteins: two-armed ATPases for chromosome condensation, cohesion, and repair. *Genes Dev.* **16**, 399-414.
- Holt, C. L. and May, G. S. (1996). An extragenic suppressor of the mitosis-defective bimD6 mutation of *Aspergillus nidulans* codes for a chromosome scaffold protein. *Genetics* **142**, 777-787.
- Hoque, M. T. and Ishikawa, F. (2002). Cohesin defects lead to premature sister chromatid separation, kinetochore dysfunction, and spindle-assembly checkpoint activation. *J. Biol. Chem.* **277**, 42306-42314.
- Kimura, K. and Hirano, T. (2000). Dual roles of the 11S regulatory subcomplex in condensin functions. *Proc. Natl. Acad. Sci. USA* **97**, 11972-11977.
- Kobe, B. and Kajava, A. V. (2000). When protein folding is simplified to protein coiling: the continuum of solenoid protein structures. *Trends Biochem. Sci.* **25**, 509-515.
- Kumar, D., Sakabe, I., Patel, S., Zhang, Y., Ahmad, I., Gehan, E. A., Whiteside, T. L. and Kasid, U. (2004). SCC-112, a novel cell cycle-regulated molecule, exhibits reduced expression in human renal carcinomas. *Gene* **328**, 187-196.
- Lee, J. Y. and Orr-Weaver, T. L. (2001). The molecular basis of sister-chromatid cohesion. *Annu. Rev. Cell Dev. Biol.* **17**, 753-777.
- Leignon, A., Katou, Y., Mori, S., Yokobayashi, S., Kelly, G. P., Itoh, T., Watanabe, Y., Shirahige, K. and Uhlmann, F. (2004). Cohesin relocation from sites of chromosomal loading to places of convergent transcription. *Nature* **430**, 573-578.
- Losada, A., Hirano, M. and Hirano, T. (1998). Identification of *Xenopus* SMC protein complexes required for sister chromatid cohesion. *Genes Dev.* **12**, 1986-1997.
- Losada, A., Yokochi, T., Kobayashi, R. and Hirano, T. (2000). Identification and characterization of SA/Scp3p subunits in the *Xenopus* and human cohesin complexes. *J. Cell Biol.* **150**, 405-416.
- Losada, A., Hirano, M. and Hirano, T. (2002). Cohesin release is required for sister chromatid resolution, but not for condensin-mediated compaction, at the onset of mitosis. *Genes Dev.* **16**, 3004-3016.
- Nasmyth, K. (2001). Disseminating the genome: joining, resolving, and separating sister chromatids during mitosis and meiosis. *Annu. Rev. Genet.* **35**, 673-745.
- Neuwald, A. F. and Hirano, T. (2000). HEAT repeats associated with condensins, cohesins, and other complexes involved in chromosome-related functions. *Genome Res.* **10**, 1445-1452.
- Ono, T., Losada, A., Hirano, M., Myers, M. P., Neuwald, A. F. and Hirano, T. (2003). Differential contributions of condensin I and condensin II to mitotic chromosome architecture in vertebrate cells. *Cell* **115**, 109-121.
- Ono, T., Fang, Y., Spector, D. L. and Hirano, T. (2004). Spatial and temporal regulation of condensins I and II in mitotic chromosome assembly in human cells. *Mol. Biol. Cell* **15**, 3296-3308.
- Panizza, S., Tanaka, T., Hochwagen, A., Eisenhaber, F. and Nasmyth, K. (2000). Pds5 cooperates with cohesin in maintaining sister chromatid cohesion. *Curr. Biol.* **10**, 1557-1564.
- Sonoda, E., Matsusaka, T., Morrison, C., Vagnarelli, P., Hoshi, O., Ushiki, T., Nojima, K., Fukagawa, T., Waizenegger, I. C., Peters, J. M. et al. (2001). Scc1/Rad21/Mcd1 is required for sister chromatid cohesion and kinetochore function in vertebrate cells. *Dev. Cell* **1**, 759-770.
- Stead, K., Aguilar, C., Hartman, T., Drexel, M., Meluh, P. and Guacci, V. (2003). Pds5p regulates the maintenance of sister chromatid cohesion and is upregulated to promote the dissolution of cohesin. *J. Cell Biol.* **163**, 729-741.
- Sumara, I., Vorlauffer, E., Gieffers, C., Peters, B. H. and Peters, J. M. (2000). Characterization of vertebrate cohesin complexes and their regulation in prophase. *J. Cell Biol.* **151**, 749-762.
- Sumara, I., Vorlauffer, E., Stukenberg, P. T., Kelm, O., Redemann, N., Nigg, E. A. and Peters, J. M. (2002). The dissociation of cohesin from chromosomes in prophase is regulated by Polo-like kinase. *Mol. Cell* **9**, 515-525.
- Tanaka, K., Hao, Z., Kai, M. and Okayama, H. (2001). Establishment and maintenance of sister chromatid cohesion in fission yeast by a unique mechanism. *EMBO J.* **20**, 5779-5790.
- Uhlmann, F. (2003). Chromosome cohesion and separation: from men and molecules. *Curr. Biol.* **13**, R104-R114.
- van Heemst, D., James, F., Poggeler, S., Berteaux-Lecellier, V. and Zickler, D. (1999). Spo76p is a conserved chromosome morphogenesis protein that links the mitotic and meiotic programs. *Cell* **98**, 261-271.
- van Heemst, D., Kafer, E., John, T., Heyting, C., van Aalderen, M. and Zickler, D. (2001). BimD/SPO76 is at the interface of cell cycle progression, chromosome morphogenesis, and recombination. *Proc. Natl. Acad. Sci. USA* **98**, 6267-6272.
- Vass, S., Cotterill, S., Valdeolmillos, A. M., Barbero, J. L., Lin, E., Warren, W. D. and Heck, M. M. (2003). Depletion of Drad21/Scp1 in *Drosophila* cells leads to instability of the cohesin complex and disruption of mitotic progression. *Curr. Biol.* **13**, 208-218.
- Waizenegger, I. C., Hauf, S., Meinke, A. and Peters, J. M. (2000). Two distinct pathways remove mammalian cohesin from chromosome arms in prophase and from centromeres in anaphase. *Cell* **103**, 399-410.
- Wang, F., Yoder, J., Antoshechkin, I. and Han, M. (2003). *Caenorhabditis elegans* EVL-14/PDS-5 and SCC-3 are essential for sister chromatid cohesion in meiosis and mitosis. *Mol. Cell Biol.* **23**, 7698-7707.
- Wang, S. W., Read, R. L. and Norbury, C. J. (2002). Fission yeast Pds5 is required for accurate chromosome segregation and for survival after DNA damage or metaphase arrest. *J. Cell Sci.* **115**, 587-598.
- Weitzer, S., Lehane, C. and Uhlmann, F. (2003). A model for ATP hydrolysis-dependent binding of cohesin to DNA. *Curr. Biol.* **13**, 1930-1940.